

 **AVAILABLE WHILE SUPPLIES LAST**

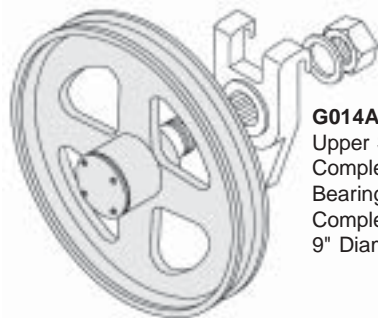

G014AU
Upper Saw Wheel Assembly
Complete with Hanger, Shaft,
Bearing & Hub Cap
Complete & Ready to Install
9" Diameter



G015L
Lower Saw Wheel
9" Diameter

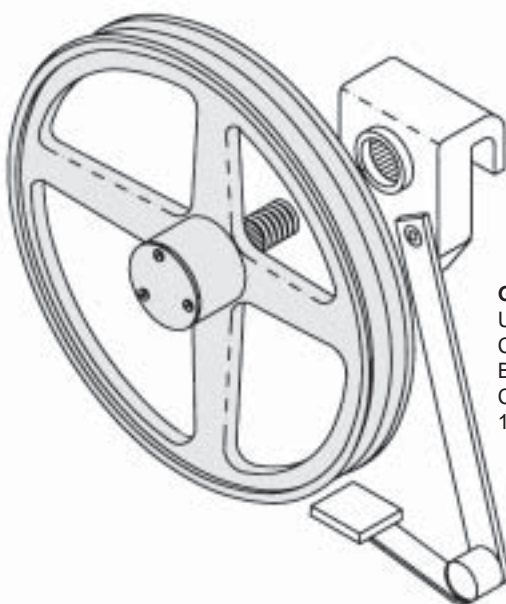

G021AU
Upper Saw Wheel Assembly
Complete with Hanger, Shaft,
Bearing and Hub Cap -
Complete and Ready to Install
15 3/4" Diameter

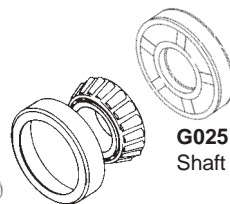

G023
Lower Main Bearing

G025
Shaft Seal



G024LS
Lower Shaft



G022L
Lower Saw Wheel
15 3/4" Diameter

FITS MODELS

NBS P/N	OEM P/N	DESCRIPTION	79	140	160
G014AU	7-165	Upper Saw Wheel Assembly	X		
G015L	7-164	Lower Saw Wheel	X		
G021AU	160-5	Upper Saw Wheel Assembly			X
G022L	160-4	Lower Saw Wheel			X
G023	140-65	Lower Main Bearing		X	X
G024LS	140-14	Lower Shaft		X	X
G025	N/A	Shaft Seal		X	X

The above described parts are supplied by **National Band Saw Company** as replacement parts for **Globe** equipment.

 **AVAILABLE WHILE SUPPLIES LAST**

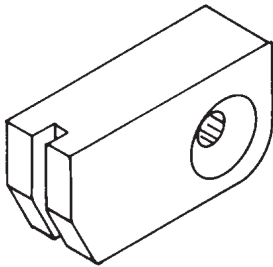

G001
Filler Block

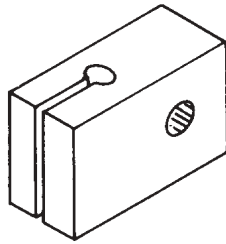

G002
Lower Saw Guide

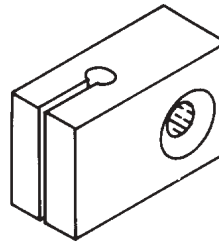

G003
Lower Saw Guide

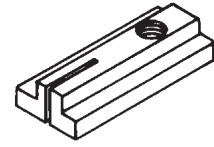

G004
Upper Saw Guide

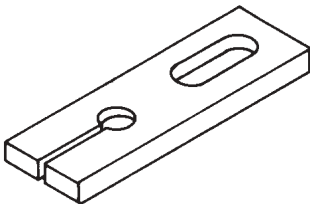

G005
Upper Saw Guide

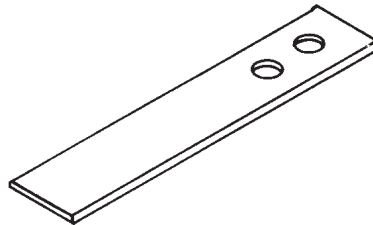

G006
Blade Scraper

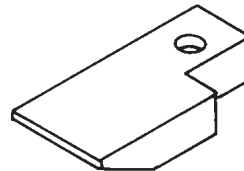

G007
Wheel Scraper

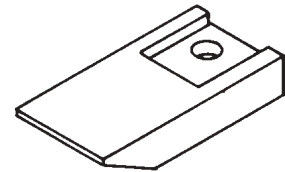

G008
Wheel Scraper

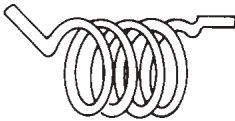

G010
Wheel Scraper Spring

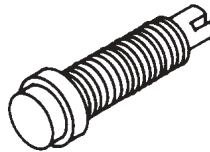

G011
Thrust Tip Assembly

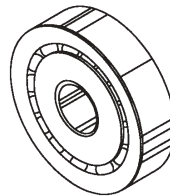

G012
Table Roller

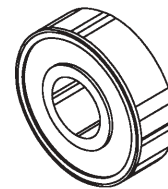

G013
Saw Guide Bearing

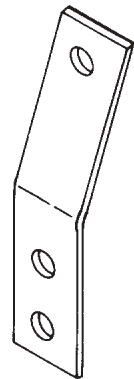

G009
Wheel Scraper Spring

FITS MODELS

NBS P/N	OEM P/N	DESCRIPTION	72	79	111	140	160
G001	140-47	Filler Block	X	X	X	X	X
G002	140-46	Lower Saw Guide			X	X	X
G003	72-46	Lower Saw Guide	X	X			
G004		Upper Saw Guide	X	X			
G005		Upper Saw Guide			X	X	X
G006	140-32	Blade Scraper	X	X	X	X	X
G007		Wheel Scraper	X	X			
G008	140-90	Wheel Scraper			X	X	X
G009	140-89	Wheel Scraper Spring			X	X	X
G010		Wheel Scraper Spring	X	X			
G011	140-244	Thrust Tip Assembly			X	X	X
G012		Table Roller	X	X	X	X	X
G013		Saw Guide Bearing	X				

The above described parts are supplied by **National Band Saw Company** as replacement parts for **Globe** equipment.

AVAILABLE WHILE SUPPLIES LAST

GRK-1
Globe Saw Repair Kit
Model 72

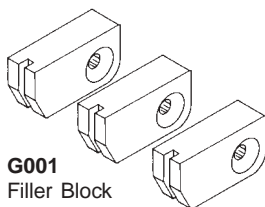
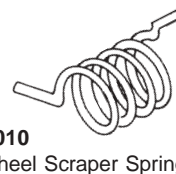
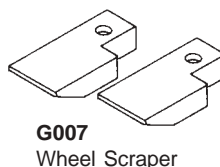
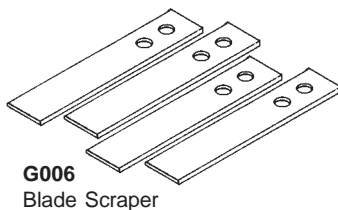
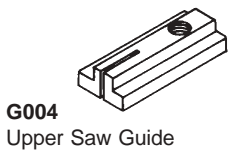

AVAILABLE WHILE SUPPLIES LAST

GRK-2
Globe Saw Repair Kit
Model 79

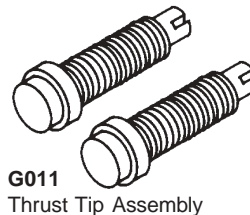
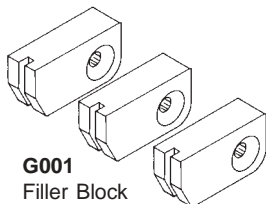
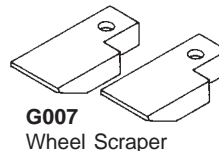
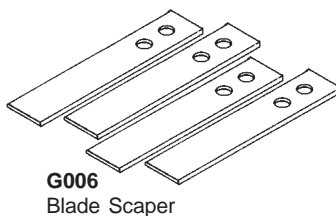

AVAILABLE WHILE SUPPLIES LAST

GRK-3
Globe Saw Repair Kit
Model 160

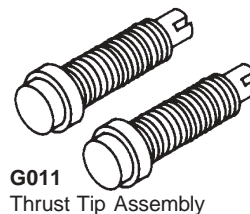
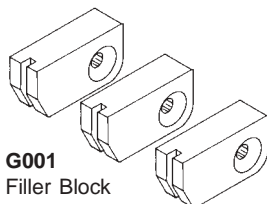
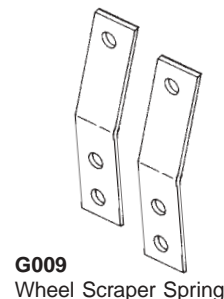
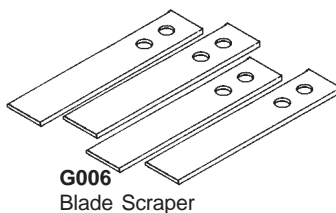

The above described parts are supplied by **National Band Saw Company** as replacement parts for **Globe** equipment.